

UN Certification: 3H2/Y19/S 

Cover Specification

Origin of Materials	100% US Manufactured
Material	High Density Polyethylene (HDPE)
Weight	7/8 lbs. / 390 g
Height	1"
Min Wall Thickness	0.10"
Outside Diameter	9 1/4"x 11 7/8"
Gasket	NA
Standard Color	White <i>Please inquire about custom colors</i>
Shipping Quantity	54 per case / 432 per pallet

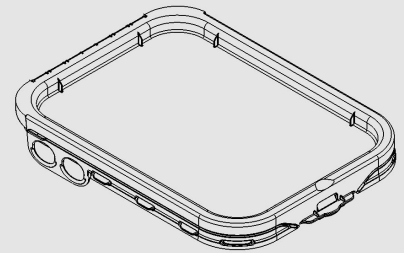

Pail Specification

Origin of Materials	100% US Manufactured
Material	Polypropylene
Handles	Plastic
Weight with handle	1 3/4lbs. / 800g
Exterior Height	14 1/2" with cover 14 3/4"
Min. Wall Thickness	0.06"
Outside Diameter - Top	9 1/4"x 12 3/8"
Outside Diameter - Bottom	7 3/4"x 10 7/8"
Standard Color	White <i>Please inquire about custom colors</i>
Shipping Quantity	192 Units per Pallet 8,064 Units per Truckload
Print Area	36.6238" x 13.1595

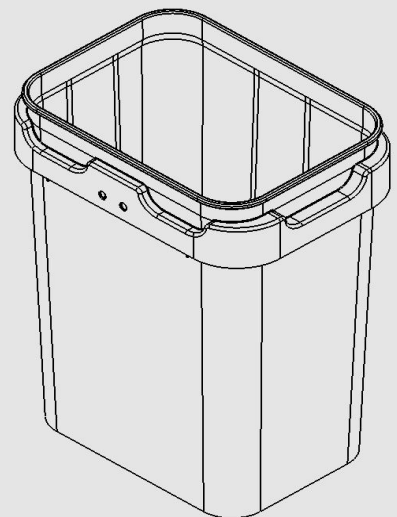

Pack Specifications For Cover

- 432 Units
- 3 stacks x 18 high per box
- 4 boxes per layer x 2 high
- Lid material is HDPE

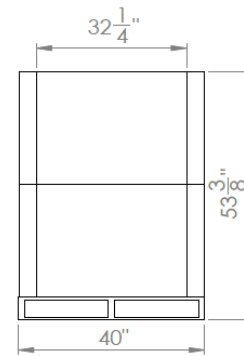
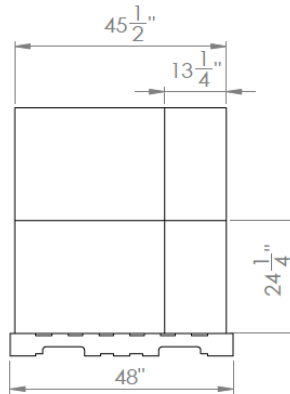
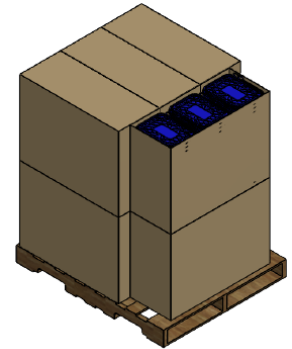
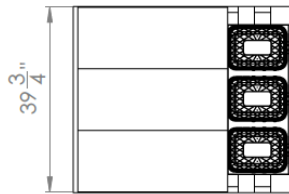

Pack Specifications For Pail

- 192 Units
- 16 Stacks x 12 High
- Pail Material is PP

