

UN Certification: 3H2/Y14/S 

Cover Specification

Origin of Materials	100% US Manufactured
Material	HDPE
Weight	7/8 lbs. / 390 g
Height	1"
Min Wall Thickness	0.10"
Outside Diameter	9 1/4"x 11 7/8"
Gasket	NA
Standard Color	White <i>Please inquire about custom colors</i>
Shipping Quantity	54 per case / 432 per pallet

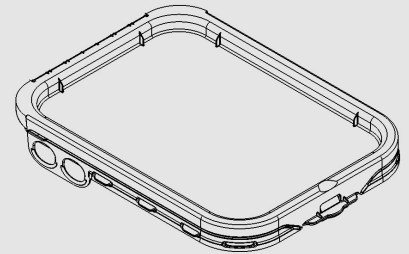

Pail Specification

Origin of Materials	100% US Manufactured
Material	Polypropylene
Handles	Plastic
Weight	1 1/4 lbs. / 580 g
Exterior Height	9 3/4" With Cover 9 7/8"
Min. Wall Thickness	0.06"
Outside Diameter - Top	9 1/4"x 12 3/8"
Outside Diameter - Bottom	7 7/8"x 11 1/8"
Standard Color	White <i>Please inquire about custom colors</i>
Shipping Quantity	224 Units per Pallet 7840 Units per Truckload
Print Area	6 7/8"x 38 1/8" In Mold Labeling (IML) 360° Unobstructed Real Estate Below Beam to Bottom Edge Including Corners

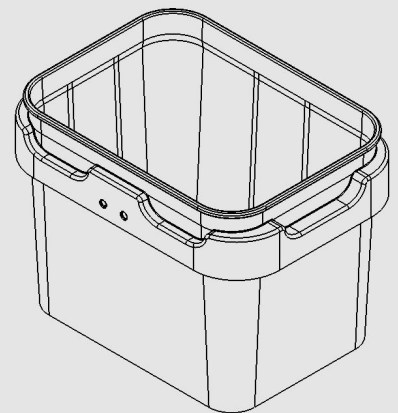

Pack Specifications For Cover

- 432 Units
- 3 stacks x 18 high per box
- 4 boxes per layer x 2 high
- Lid material is (HDPE)

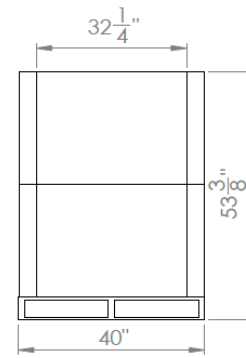
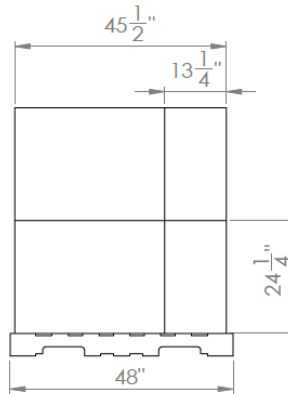
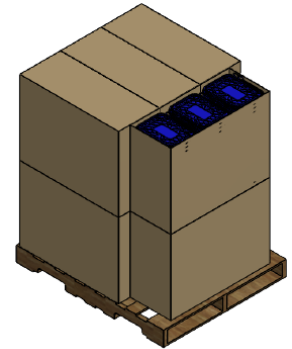
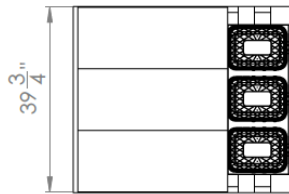

Pack Specifications For Pail

- 224 Units
- 16 Stacks x 14 High
- Pail Material is PP

